



PepperBall®
SAFER OPTIONS

FlashLauncher™

User Manual



FlashLauncher™

WARNINGS & SAFETY PAGE 3

GETTING STARTED PAGE 8

BATTERY INSTALLATION PAGE 9

CHARGING THE BATTERYPAGE10

INSERTING CO₂ CARTRIDGEPAGE 11

LOADING PROJECTILES PAGE 12

FIRING LAUNCHER PAGE 13

LASER ADJUSTMENT PAGE 14

CLEANING AND MAINTENANCE PAGE 15

WARRANTY & DISCLAIMERS PAGE 16

RETURN POLICY PAGE 17

WARNING

THIS LAUNCHER IS NOT A TOY AND IS INTENDED FOR USE BY MILITARY, LAW ENFORCEMENT, CORRECTIONAL OFFICERS, PRIVATE SECURITY GUARDS, BAIL ENFORCEMENT AGENTS AND OTHER AUTHORIZED PERSONNEL. THIS PRODUCT LAUNCHES PROJECTILES FROM THE BARREL. MISUSE MAY CAUSE SERIOUS INJURY OR DEATH. ALWAYS MAKE SURE THAT THE TRIGGER SAFETY IS IN THE "SAFE MODE," EXCEPT WHEN THE LAUNCHER IS IN USE. SEE ADDITIONAL SAFETY GUIDELINES AND USER INSTRUCTIONS IN THIS MANUAL. KEEP OUT OF THE REACH OF CHILDREN.

WARNINGS AND SAFETY

Congratulations on your purchase of the PepperBall FlashLauncher™.

This launcher has been designed and manufactured by United Tactical Systems, LLC (UTS) to be reliable, accurate and durable. When properly handled, the FlashLauncher™ will give many years of dependable service. Please take the time to read through this manual and become familiar with the FlashLauncher™ parts, operation, maintenance, and safety precautions before you attempt to load or fire this launcher. This manual is a supplement to the recommended PepperBall® training and should be used as a reference when performing maintenance or annual re-qualification.

By purchasing this launcher, you and your agency assume total responsibility for its safe and lawful use. You must observe the same safety precautions as you would with any firearm to ensure the safety of not only yourself, but everyone around you. The operator should use caution at all times when maintaining and firing this launcher.

LIMITATIONS AND USAGE

There are some state or local limitations on purchase, possession, and use of the FlashLauncher™. Verify local legal requirements in your state and city to ensure possession and use are proper. The user assumes the liability from unsafe or improper use or any action which constitutes a violation of any applicable law or regulation.

The FlashLauncher™ may be prohibited from certain premises, including government buildings, airports, courthouses, schools, or other public spaces. Possessing a FlashLauncher™ in a prohibited area may subject user to criminal liability.

WARNING: If misused, this PepperBall® launcher is a dangerous weapon.

The user assumes all liability from unsafe handling or any action that constitutes a violation of any applicable laws or regulations. UTS shall not be liable for personal injury, loss of property, or loss of life resulting from the use of this weapon under any circumstances, including any intentional, reckless, negligent or accidental discharges. By using this PepperBall® launcher, you release UTS of any and all liability associated with its use.

All information in this manual is subject to change without notice. UTS reserves the right to make changes and improvements to products without incurring any obligation to incorporate such improvements in products previously sold.

IF YOU DO NOT ACCEPT LIABILITY, DO NOT USE THIS OR ANY PEPPERBALL® LAUNCHER.

WARNING: This product contains chemicals known to the State of California to cause cancer and birth defects or other reproductive harm.

SAFETY IS YOUR RESPONSIBILITY!

The following safety information contains important warnings related to the proper use of the launcher, projectiles, and gas canisters. Do not load, discharge or otherwise use this launcher until you have completely read this manual and are familiar with its safety features, mechanical operation, and handling characteristics.



LAUNCHERS

- **Danger:** Never aim or shoot at the head, face, eyes, ears, throat or spine. Impact in these areas could result in unintended severe or permanent injury or death.
- **Danger:** Never look down the barrel of the launcher. Accidental discharge into the eyes may cause permanent injury or death.
- Eye, face and ear protection should be worn when utilizing this system in force-on-force training.
- Handle this launcher as if it were loaded at all times.
- Keep your finger off the trigger until ready to fire.
- Keep this launcher on "Safe Mode" until ready to fire.
- Always keep the barrel pointed down or in a safe direction.
- Never point or discharge your launcher at anything you do not intend to shoot.
- Never discharge your launcher at the personal property of others.
- Do not disassemble this launcher while it is pressurized or attempt to pressurize while it is disassembled.
- Keep exposed skin away from any escaping gas when in use and when installing or removing air supply.
- Use only PepperBall® authorized projectiles in this launcher. The use of any unauthorized projectiles in this launcher will void all warranties.
- Any unauthorized modifications to the function of this launcher will void all warranties.
- Never point the laser directly at eyes and observe all safety warnings associated with the equipped laser.
- Always verify launcher is in "Safe Mode" and stored in a safe and secure location when not in use.
- USE CAUTION when engaging suspects beyond 20 meters as accuracy is reduced beyond that distance.

PROJECTILES

PEPPERBALL LIVE-X™ AND PEPPERBALL LIVE™ PROJECTILES

WARNING! THIS PRODUCT IS NOT A TOY! KEEP OUT OF THE REACH OF CHILDREN! MAY CAUSE IRRITATION UPON CONTACT OR INHALATION.

Read projectile label carefully before opening container or using any of its contents. Opening container indicates user has carefully read label in its entirety and accepts its provisions as the terms and conditions under which this product is furnished. THIS PRODUCT IS INTENDED SOLELY for use by properly trained users including military, law enforcement, private security, and corrections personnel.

IRRITATION: PAVA projectiles contain pepper powder and may cause irritation upon contact or inhalation.

SAFETY

ACTIVE INGREDIENT of PAVA-filled projectiles: Approximately 0.5% in LIVE projectiles and 5.0% in LIVE X projectiles +/- 0.02% by weight PAVA (with CAPAICIN II) Capsaicinoids 1.0% per A.S.T.A. 21.3

EXPOSURE:

Eye Contact: Flush eyes and other contaminated areas IMMEDIATELY with large amounts of cool water, and expose to fresh air. Contact lenses should be removed by subject or qualified medical personnel and must be discarded.

Skin Contact: Wash skin with soap and water to prevent further exposure. Flush skin with large amounts of cool water to minimize irritant effect. Wash contaminated clothing before reuse. DO NOT rub contaminated areas or apply creams, salves, oils, lotions, or burn cream, which can trap irritant on the skin.

Inhalation: If breathing is difficult, administer oxygen. If high concentrations are inhaled, immediately remove subject to fresh air. Keep person calm. If not breathing, begin artificial respiration. If breathing difficulty persists, seek medical attention.

Ingestion: Although ingestion is unlikely and not considered a potential route of exposure, individual should be treated as having an acute non-specific airway reaction by an appropriate specialist. Do not induce vomiting.

For more details on these products, please refer to the Safety Data Sheets (SDS) listed on www.pepperball.com

STORAGE AND DISPOSAL: Store in areas inaccessible to children. Do not store where temperature may exceed 150°F. Discard safely three (3) years from date of manufacture. PEPPERBALL patented products are protected by one or more of U.S. Patent Numbers 5,965,839; 6,393,992; 6,543,356; 6,546,874; 7,194,960: European Patent Number 1177409; and/or other domestic and foreign patent pending applications. For information, call (877) 887-3773 or go to www.pepperball.com.

GLASS-SHATTERING PROJECTILES

WARNING! NOT INTENDED FOR USE ON HUMANS! KEEP OUT OF THE REACH OF CHILDREN!

Glass-Shattering Projectiles should only be used for breaking automobile side windows or residential windows. These projectiles are NOT recommended to be used as anti-personnel projectiles. Projectiles should NOT be reused. Dispose of all previously launched projectiles. By opening the container and breaking the sealed cap, the agency and the user agree to abide by all manufacturer's recommendations. Discard safely six (6) years from date of manufacture.

CO₂ CANISTERS

WARNING-CONTENTS UNDER PRESSURE

Do not puncture or incinerate container. Do not expose to heat or store at temperatures above 120°F. Keep out of the reach of children.

After firing 15 consecutive shots within any ten-minute timeframe, ice conditions may form around critical areas of the FlashLauncher due to the CO₂ gas from the 12-gram cartridge. Before continued use, allow a 15-minute break prior to firing any additional rounds.



INCLUDED PARTS & TOOLS

- BATTERY TRAY
- RECHARGEABLE BATTERY
- CAR CHARGER
- WALL CHARGER WITH ADAPTERS
- HOLSTER

OPERATIONAL INSTRUCTIONS OVERVIEW

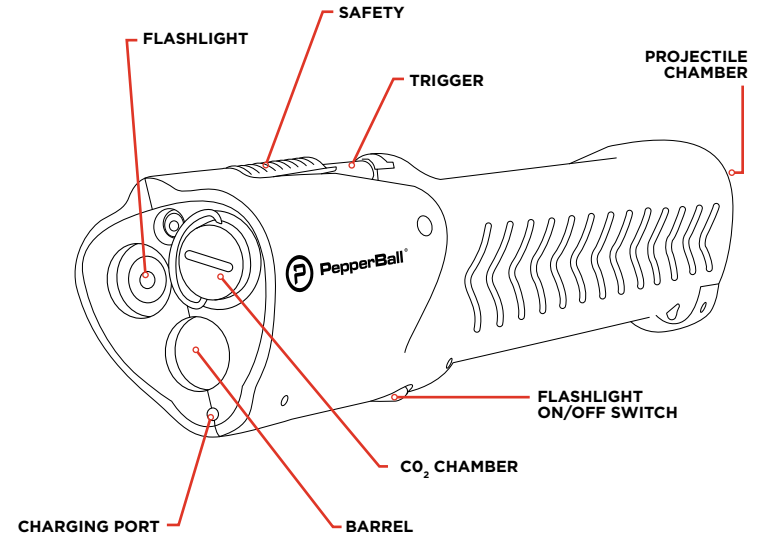

FLASHLAUNCHER™ SPECIFICATIONS

Caliber	.68	Weight	1.75lbs/.79kg
Action	Semi-auto	Magazine Capacity	5 rounds
Power	CO ₂	Target Range Round	30ft/9.1m
Length	11in/27.9cm	Muzzle Velocity	280-320 FPS
Height	2.5in/6.3cm	Light Output	180 Lumens



GETTING STARTED

LANYARD & SAFETY PIN

1. ATTACHING LANYARD - Insert the lanyard through the end opening of the FlashLauncher™ and loop through the opening and pull tight..

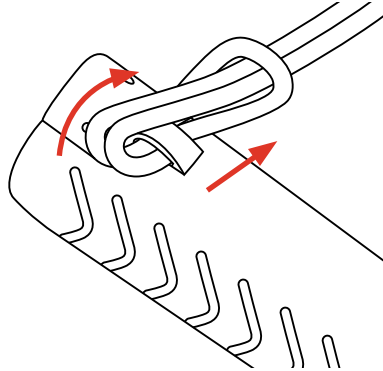

2. SAFETY PIN REMOVAL - Remove the Safety Pin before using the FlashLauncher™. The Safety Pin has been installed as safety against accidental firing. The Safety Pin should remain in place when the FlashLauncher™ is not in use.

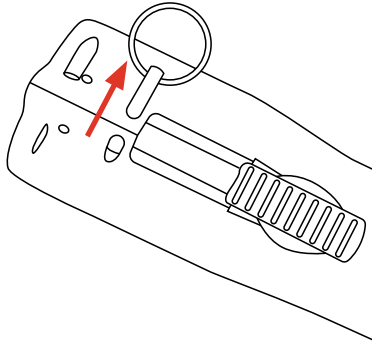

3. SECURE THE SAFETY PIN - Attach the pin to the end of the lanyard for future desired safety and use.

OPERATIONAL INSTRUCTIONS

BATTERY INSTALLATION

1. PLACE THE FLASHLAUNCHER™ IN SAFE MODE - Slide the safety towards the rear of the launcher until it is fully covering the trigger.

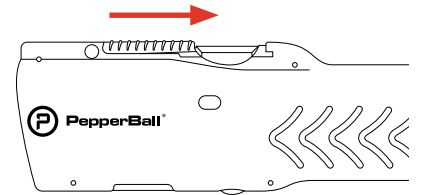

2. REMOVE THE BATTERY COVER

A. To install non-rechargeable batteries, attach the Battery Tray Connector to the launcher. Place two batteries in the Battery Tray, following the correct placement of + or -.

B. To install rechargeable batteries, disconnect the Battery Tray Connector, (if connected), from the launcher, and attach the connector of the rechargeable battery in its place.

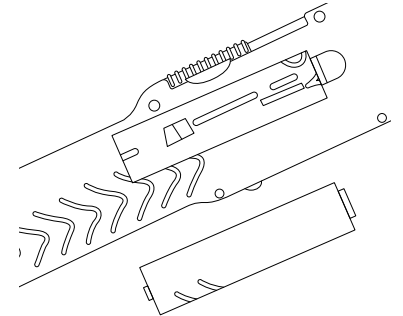

3. REPLACE THE BATTERY COVER - Ensure the Battery Door is closed, by pushing the latch forward until it clicks.

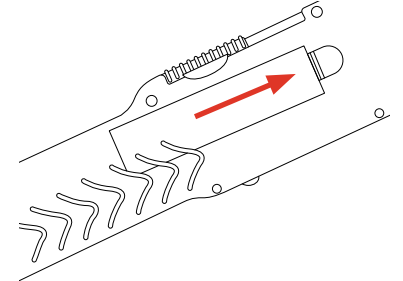



OPERATIONAL INSTRUCTIONS

CHARGING THE BATTERY

1. Place the FlashLauncher™ in safe mode.
2. Locate the charging jack on the front of the FlashLauncher™.
3. Insert either the A/C wall charger or D/C car charger into the jack.
4. Plug the charger into a power source.

WARNING: DO NOT leave the flashlight on when charging the battery. Leaving the flashlight on during battery recharge may result in damaging the LED.

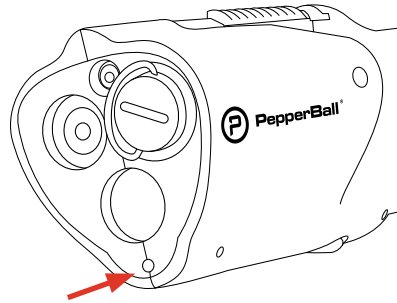

OPERATIONAL INSTRUCTIONS

INSERTING CO₂ CARTRIDGE

1. Unscrew Puncture Ram from cartridge chamber located in the front of the FlashLauncher™.

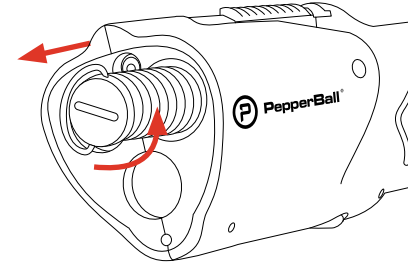

2. Insert recommended 12 gram CO₂ cartridge (skinny end first) into the cartridge chamber where you removed the Puncture Ram. (CO₂ cartridge is not included)
3. Re-install Puncture Ram into cartridge chamber and tighten until Puncture Ram is flush with the front of the unit.

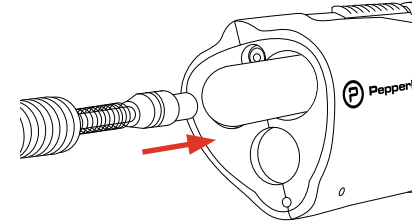

NOTE: PepperBall® recommends the user only install 12 gram cartridges that have been ASTM certified to meet size standards.

REPLACING SPENT CO₂ CARTRIDGE

1. To replace the spent CO₂ cartridge, ensure the launcher is empty of projectiles.
2. Unscrew the Puncture Ram from the launcher.
3. Point the launcher in a safe direction, and at a downward angle.
4. Disengage the safety, and press the trigger.
5. The spent CO₂ cartridge should release and fall free of the launcher.
6. Engage the safety and install a fresh CO₂ cartridge, or replace the Puncture Ram on an empty chamber for storage.
7. Engage the safety and install a fresh CO₂ cartridge, and replace the Puncture Ram.
8. Properly dispose of the spent CO₂ cartridge.



OPERATIONAL INSTRUCTIONS

LOADING PROJECTILES

1. Remove Projectile Cartridge from the rear of the FlashLauncher™ by pushing in and turning approximately 1/8 turn clockwise. A tab on the Projectile Cartridge will line up with a notch in the body of the FlashLauncher™ so it can be removed.

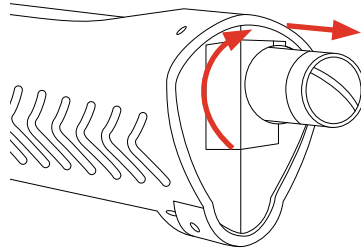

2. Place five PepperBall® projectiles into the Cartridge chamber where you removed the Projectile Cartridge. Reinsert the Projectile Cartridge and turn it approximately 1/8 turn counterclockwise until it locks back into place.

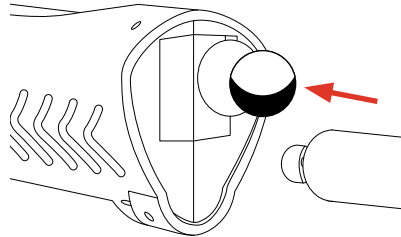

NOTE: Never place more than five PepperBall® projectiles in the FlashLauncher™.

OPERATIONAL INSTRUCTIONS

FIRING THE FLASHLAUNCHER™

1. The FlashLauncher™ is now ready to fire. Aim the FlashLauncher™ at the intended target and slide the safety to the forward position. This will activate the laser and also reveal the red trigger. Aim the laser on the target and firmly press the red trigger down with your thumb. Press the Red Trigger firmly until Projectile is launched and straight down.

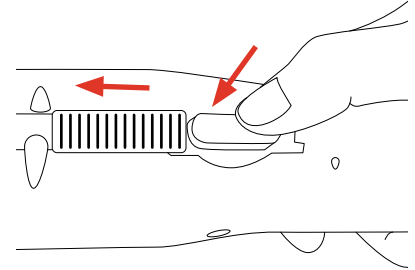

2. When no longer launching projectiles at the intended target; first lower FlashLauncher™ towards ground and then slide safety rearward to cover red trigger. **ALWAYS keep red trigger covered when not in use.**

3. Replace the 12 gram CO₂ cartridge after firing five projectiles or any time the FlashLauncher™ will be stored. NOTE: CO₂ cartridge will be pierced only at first trigger push each time the FlashLauncher™ is reloaded with a new cartridge.

WARNINGS:

- Never point laser direct into eyes
- Do not shoot at head, neck or spine
- Do not shoot FlashLauncher™ at unintended target

STORING THE FLASHLAUNCHER™

If storing the FlashLauncher™ for an extended period and it is not intended to be used, replace the Puncture Ram on an empty chamber, ensure the launcher is free of projectiles. Place the FlashLauncher™ in the case, and store in a safe location.



OPERATIONAL INSTRUCTIONS

ADJUSTING LASER SIGHT

1. Secure the FlashLauncher™ in a horizontal position with the trigger pointing up.
2. Once secure, shoot one round from the FlashLauncher™ at a target from 15 feet away. The projectile should hit within a 1.5" square from where the laser is projecting.
3. If the projectile did not hit within the specified range, use the two adjustment screws at the front of the launcher to adjust the laser until it is within range. The left screw adjusts the elevation, the right screw adjusts windage.

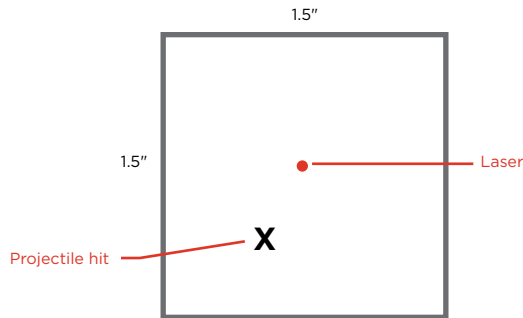
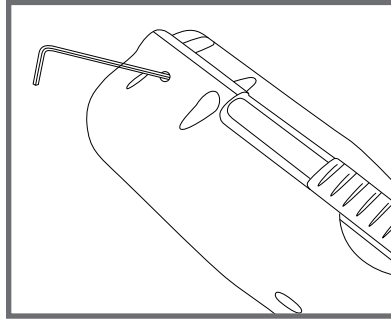

CLEANING AND MAINTENANCE

SAFETY NOTES

WARNING: Never perform cleaning or maintenance on a loaded or pressurized launcher.

- Remove all projectiles from magazine as well as remove the CO₂ / N₂ cartridge from the Flashlauncher™ prior to doing any cleaning or maintenance
- To clean the launcher, use a .68 caliber soft nylon brush or 12 gauge patch tip with a soft cotton cloth to clean the barrel.
- Keep the barrel of the launcher completely dry. Do not place lubricant or water in the barrel of the launcher. The launcher is designed to be used with the barrel completely dry.
- Never use petroleum-based cleaning solvents or lubricants.
- Never use cleaning solvents that come in aerosol cans.



WARRANTY AND DISCLAIMER

WARRANTY, DISCLAIMER OF WARRANTY AND LIMITATION OF REMEDIES

United Tactical Systems, LLC (UTS) warrants, solely to the end user, law enforcement agencies, private security firms, or private or public corrections agencies, that the product is delivered free from defects in materials and workmanship for a period of one (1) year from the original date of purchase.

Within the one-year warranty period, UTS's liability and the buyer's sole and exclusive remedy hereunder for all claims shall be limited to a refund or credit to buyer of the purchase price, or replacement of this product, at UTS's option, provided that the non-conforming product is (1) returned during the warranty period and (2) properly packaged and shipped to UTS's designated facility in accordance with UTS's Return Merchandise Authorization (RMA) Policy.

THE REMEDY SET FORTH ABOVE SHALL BE THE SOLE AND EXCLUSIVE REMEDY FOR BREACH OF THE FOREGOING WARRANTY.

Products which have been improperly handled, stored or shipped, or which have been subject to abuse, misuse, alteration and or neglect are not covered by the warranty. Aftermarket products and the use of non-authorized projectiles are strictly prohibited by UTS and any indication of their installation or use shall void all warranties.

DISCLAIMER OF WARRANTY: Except for the express limited warranty set forth above, UTS makes no warranties or representations of any kind, whether express or implied, with respect to the product, including any (a) warranty of merchantability; or (b) warranty of fitness for a particular purpose; or (c) warranty against infringement of intellectual property rights of a third-party, whether express or implied by law, course of dealing, course of performance, usage of trade or otherwise. There are no warranties which extend beyond the description of the face hereof. Buyer shall make no warranty or representation regarding the products that is inconsistent with the warranty set forth above. UTS shall not be liable for any injury, loss, or damage, direct or consequential, arising out of the use or the inability to use this product.

Before use, the user shall determine the suitability of the product and be fully trained for its intended use, and user assumes all risks and liability whatsoever in connection therein. In no event shall UTS be liable or obligated to buyer or to any third party in any manner for any (a) special, non-compensatory, consequential, indirect, incidental, statutory, or punitive damages of any kind, including, without limitation, lost profits and/or lost revenue, regardless of the form of action, whether in contract, tort, negligence, strict product liability, or otherwise, even if informed of or aware of the possibility of any such damages in advance, (b) in an amount greater than the amounts paid to UTS by buyer for the products, or (c) damage or injury caused by the products, unless due to the gross negligence or willful misconduct of UTS. The limitations set forth above shall be deemed to apply to the maximum extent permitted by applicable law and notwithstanding the failure of the essential purpose of any limited remedies. The parties acknowledge and agree that they have fully considered the foregoing allocation of risk and find it reasonable, and that the foregoing limitations are an essential basis of the bargain between the parties.

RETURN POLICY

UTS RETURN MERCHANDISE AUTHORIZATION (RMA) POLICY

For warranty and non-warranty repair:

- Call UTS at 1-260-478-2500
- UTS will issue a Return Authorization (RA) number
- UTS will provide the shipment address.
- Include a brief statement regarding the requested repair, your name, your return address and a telephone number where you can be reached during normal business hours.
- CAUTION: ALWAYS UNLOAD AND REMOVE AIR SOURCE AND PROJECTILES BEFORE SHIPPING A LAUNCHER.
- CAUTION: THE AIR SOURCE MUST BE DISCHARGED.
- Please make sure that the RA number is clearly marked on the outside of the package.
- Postage and delivery charges must be pre-paid. Collect delivery charges will not be accepted.
- Products within the one-year warranty period are returned via ground shipping at no charge.
- Out-of-warranty returns require a pre-payment of shipping charges prior to return shipment by UTS.
- You may request expedited shipping at your expense with charges paid prior to return shipment.

UTS strives to complete the necessary repair work within a reasonable amount of time.

PepperBall® A Division of United Tactical Systems, LLC

www.pepperball.com | (858) 638-0236

28101 Ballard Drive, Suite F

Lake Forest, IL 60045



HEADQUARTERS

28101 Ballard Dr. Ste. F
Lake Forest, IL 60045

1-877-887-3773 | North America

+1-858-228-1439 | International

PEPPERBALL.COM

PepperBall® is a registered trademark of United Tactical Systems, LLC,
exclusive worldwide manufacturer and supplier of genuine PepperBall® products